

WWW.PHILIPPWINTERBERG.COM

Philipp Winterberg

EGBERTO SE ENROJECE

Egbert Akomi Rouge

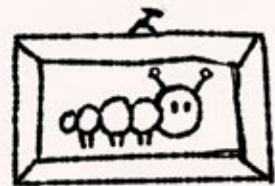

Philipp Winterberg

EGBERTO SE ENROJECE

Egbert Akomi Rouge

Philipp Winterberg

EGBERTO SE ENROJECE

Egbert Akomi Rouge



Lingala (Ngala)
Spanish (Español)

Translation (Lingala): Yeno Matuka and Day Translations

Translation (Spanish): Andrés Rodas Vélez, Manuel Bernal Márquez and EUP Team



www.philippwinterberg.com



Awa Egbert.
Este es Egberto.

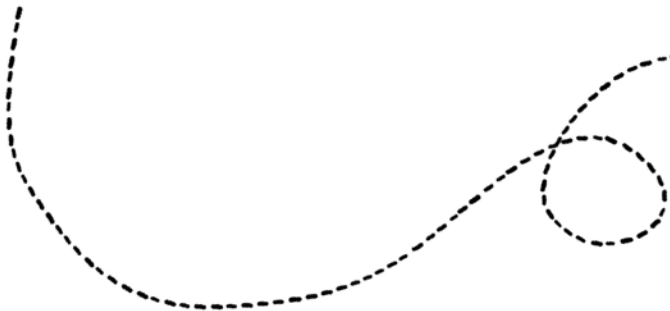

Naza Egbert.
Soy Egberto.

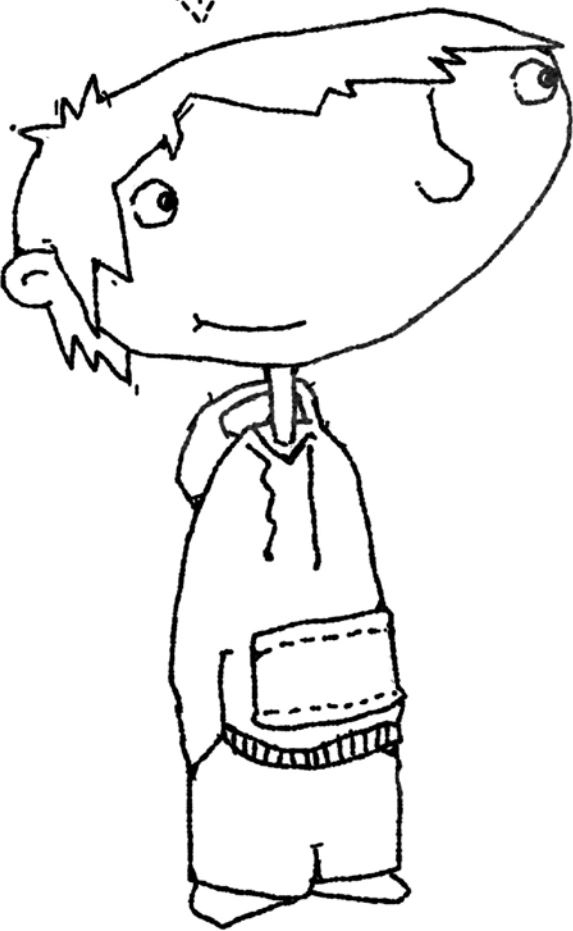



Egbert alingaka biloko ya vert.
Mingi-mingi baemerolde na
badragon.

*Egberto ama las cosas verdes.
Especialmente emeraldas
y dragones.*

Egbert alingaka bandoto ya orange te.

A Egbert no le gustan los sueños amarillos.





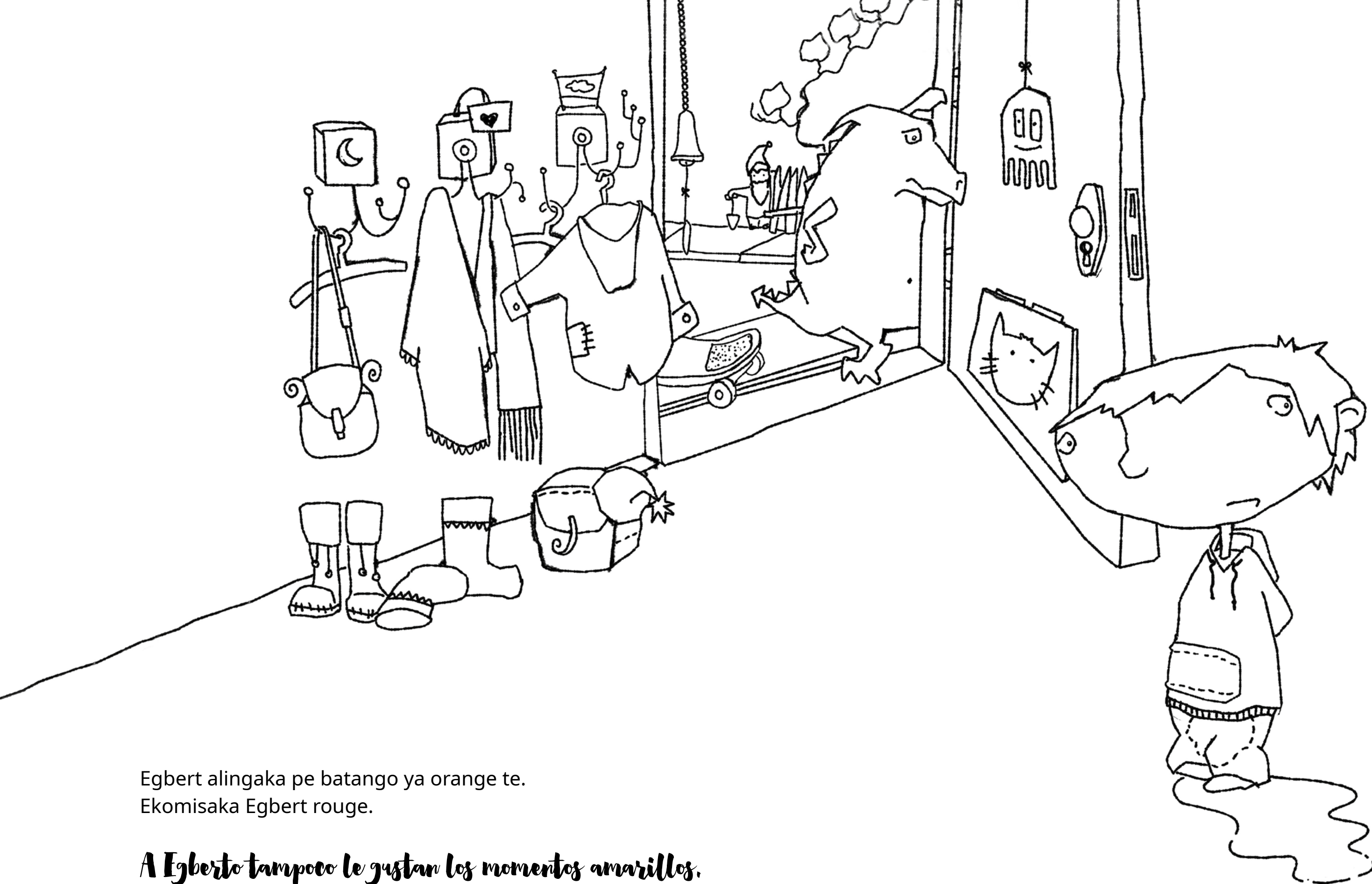

Egbert alingaka pe batango ya orange te.
Ekomisaka Egbert rouge.

*A Egberto tampoco le gustan los momentos amarillos.
Esos momentos hacen que Egberto se ponga rojo.*



Oyo Manfred.

Este es Manfred.

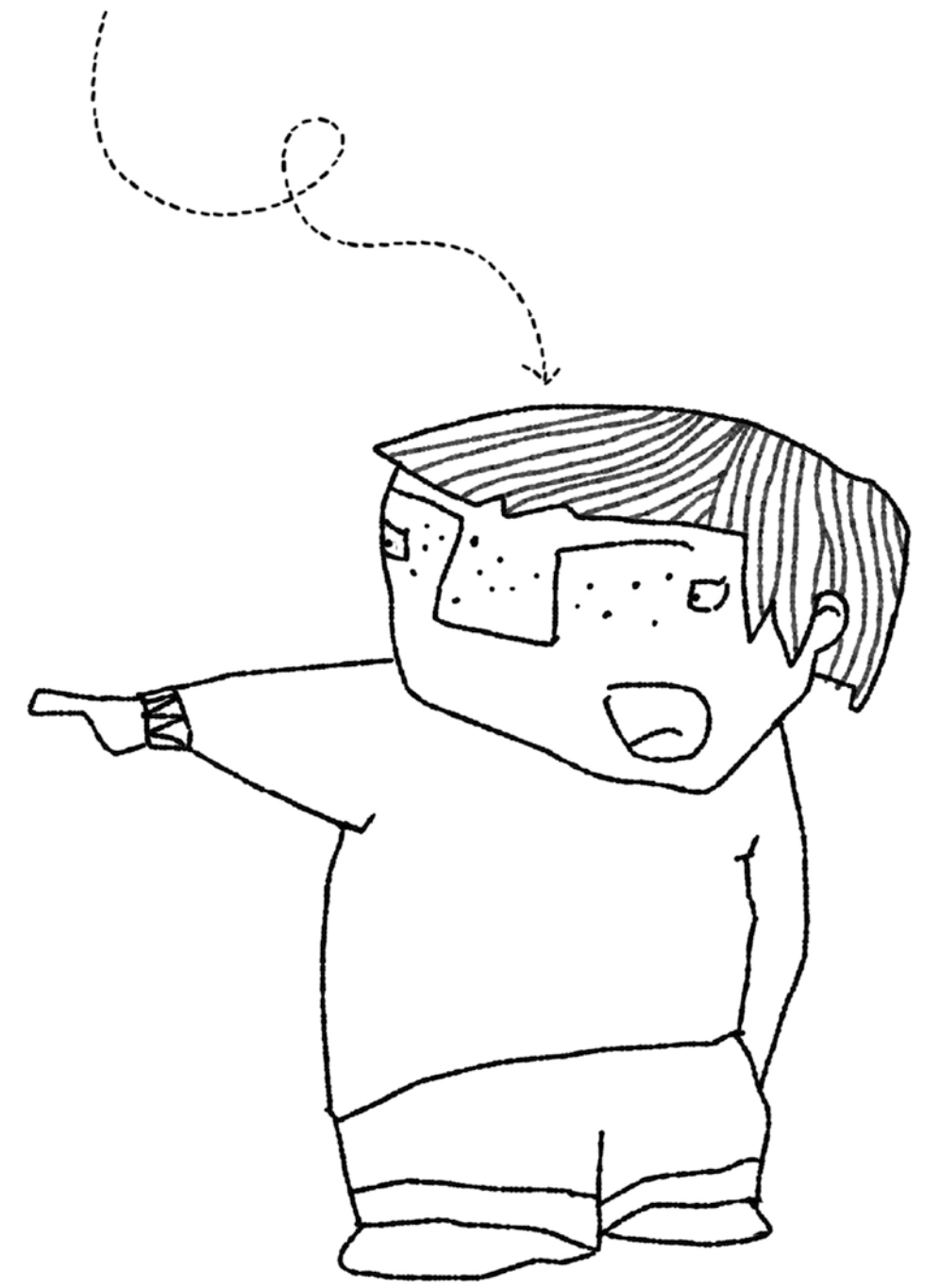



MOSUBIBERT!
MOSUBIBERT!
EGBERT AZA BÉBÉ!

¡MEA-BERTO!
¡MEA-BERTO!
¡EGBERTO ES UN BEBÉ!

Tango Manfred akomaka mabe, Egbert akomaka pe rouge.
Kanda makasi pe rouge.

*Quando Malfredo es malvado, Egberto también se
enrojece. Muy enojado y rojo.*



Zoba ya Kandafred!
Soki nazalaka ata na masini-ya-kosuba-na-pantalo!

*¡Estúpido Mal-fredo!
¡Desearia tener una máquina orina pantalones!*

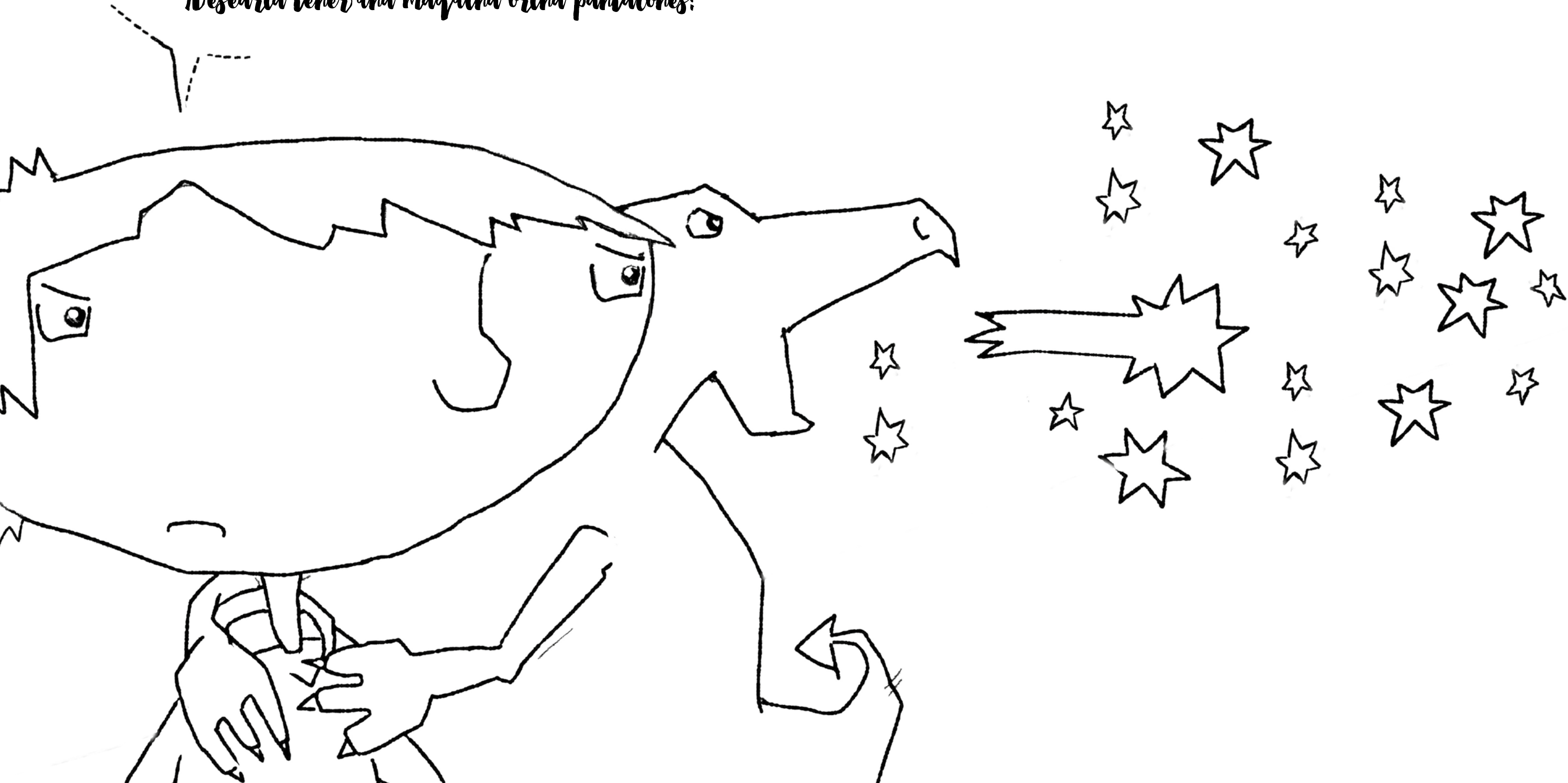



Egbert aza na pula.
Manfred ye nde a...kokamwa!

*Egberto tiene un plan.
¡Manfredo quedará... sorprendido!*







Masini-ya-kosuba-na-pantalo ekiliké pe ezo labola
pe Manfred azo suba na pantalo naye.
Pula ya Egbert ezo sala.

*La máquina orina pantalones hace "click",
alumbra y Manfred se está orinado en sus
pantalones. El plan de Egberto funciona.*

MOSUBIFRED! MOSUBIFRED!
MANFRED AZA BÉBÉ!

**¡MEA-FRED! ¡MEA-FREDO!
¡MANFREDO ES UN BEBÉ!**

**SOONIOO!!!!!!
iiiiEEEEEEEEEW!!!!!!**

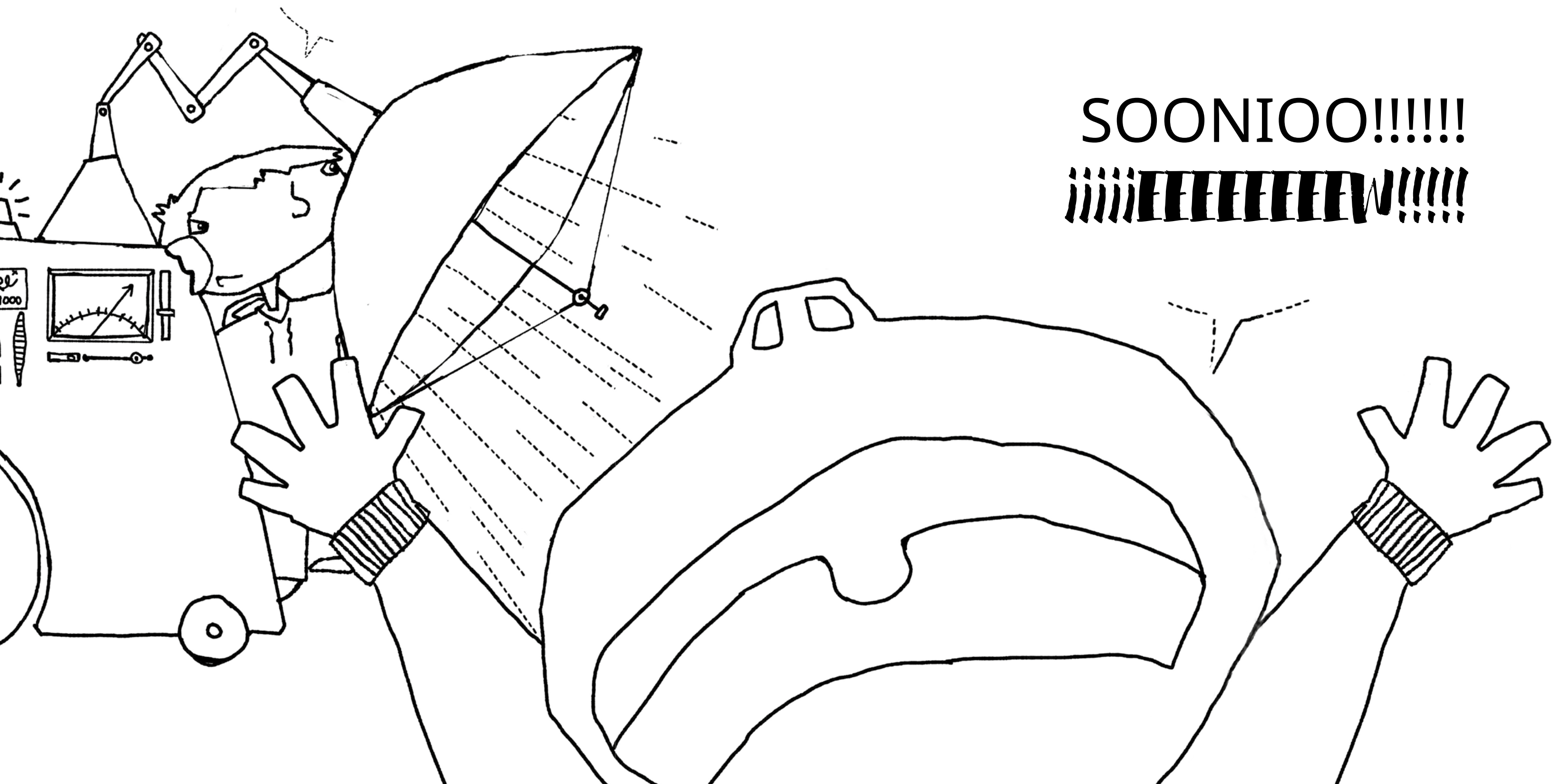





Masini-ya-kosuba-na-pantalo ezo lela pe kobetazana ebongo moto nyonso azo suba na pantalo naye. Ata Egbert na moninga naye dragon. Tango moko ya orange.

La máquina orina pantalones ruge, suena y todos se están orinando en sus pantalones. Incluso Egbert y su amigo el dragón. ¡Ah! Qué momento tan amarillo.

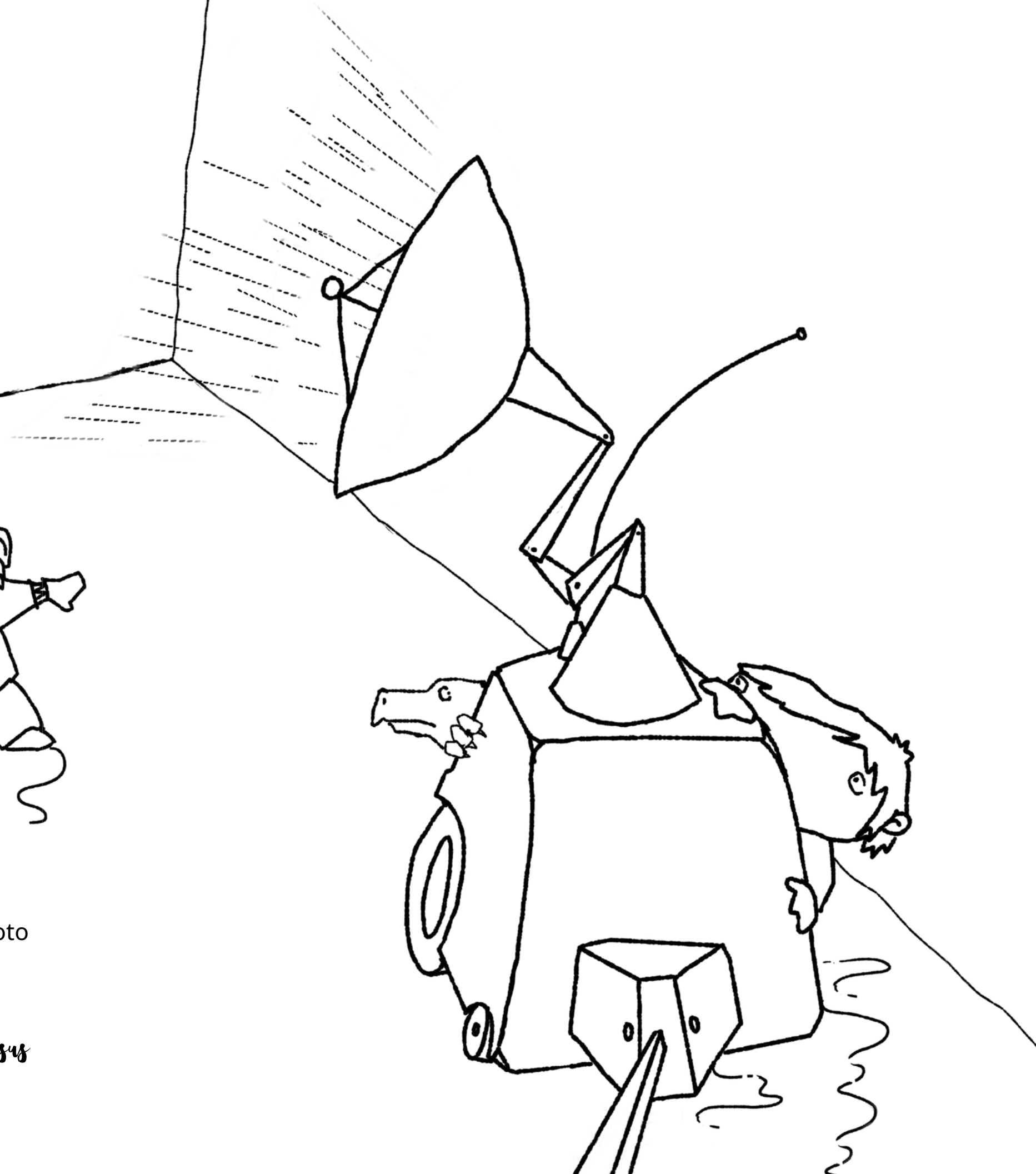

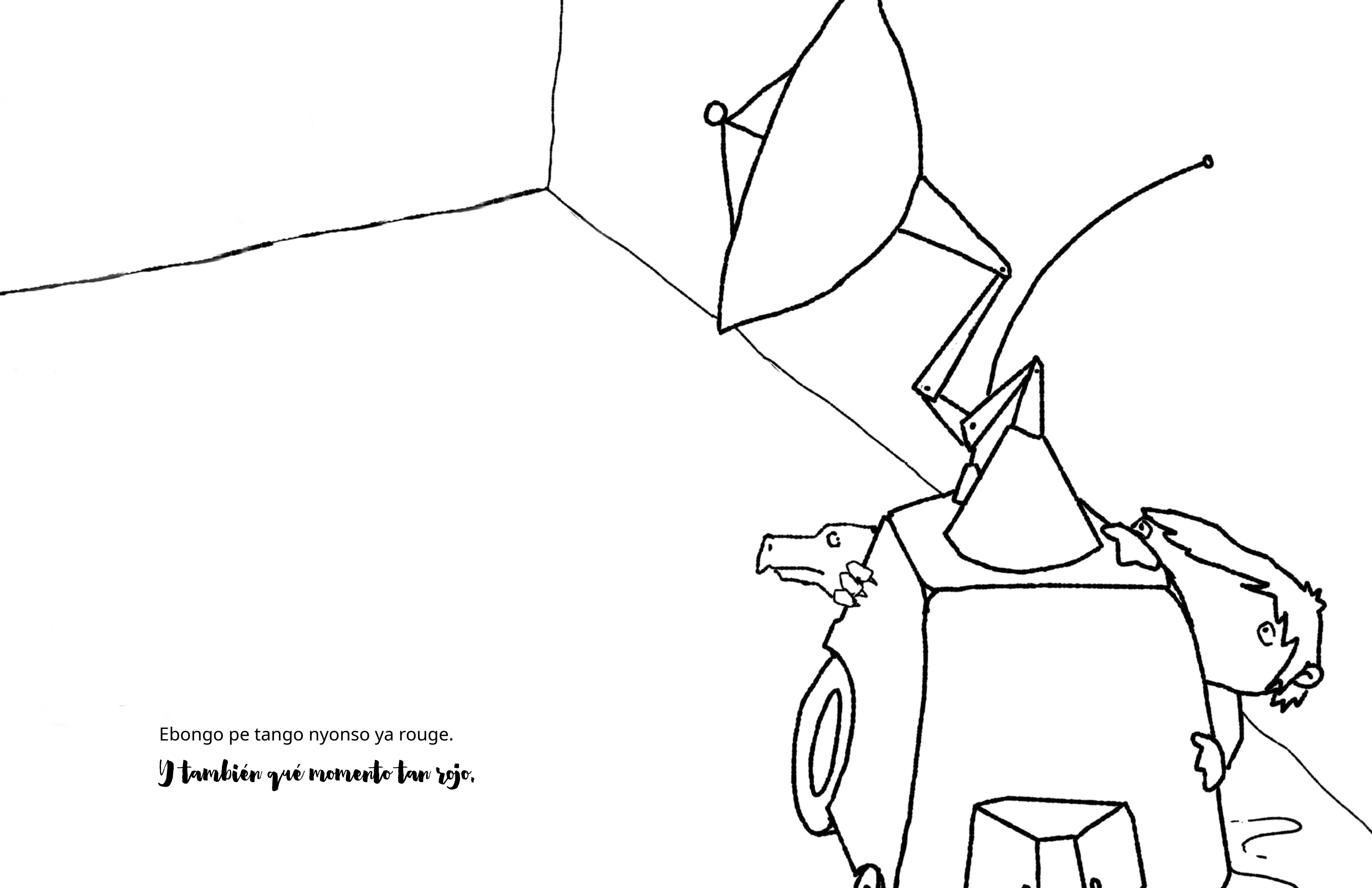

Ebongo pe tango nyonso ya rouge.

Y también qué momento tan rojo.

Oh te, nakomisi Manfred
Mosubifred pe nakomi Kandabert
ngamoko. Nayoki mawa!

*¡Oh no! Convertí a Manfredo en Mea-
fredo y me convertí en Mal-berto yo
mismo. ¡Lo siento!*

Huhm. Soki nazala ata
na ndoto ya vert!

*Suspiro. ¡Desearía
tener un sueño verde!*























¿Imprimir este libro con imágenes para niños?

Descarga este libro en más de 100 idiomas como PDF e imprímelo para tu hijo/a tanto como quieras.

No se necesita información personal, registro, correo electrónico, boletín ni obligaciones. Es simplemente gratis:

www.philippwinterberg.com

¡Muchas gracias a todos los traductores!



Abdessalam Ait Touijar, Mayumi Homma, Romy Beer, Mica Allalouf, Sandra Hamer, David Hamer, Min-Jae Dekena, Joo Yeon Kang, Anita Luft, Sampada Nakhare, Sayed Anvari, Mohamed Hosseini, Alireza Shabani, Saber Zogby, Melanie Rebasso, Abdessalam Ait Touijar, Rifaat Sadak, Chor-Tung Wong, Tamara Hveisel Hansen, Tikolx Lañam, Johnny Bravu, Roded Avinur, Txoyuk Arizkorreta, Nceba Madikizela, Charles Gerard, Mahmood Ahmad, Rocío Avi Arroyo, Omo Jesu, Ermias Abrihet, Jiangbo Zhōng, Sevdali Selmani, Raam Abdullahi, Paru Sandhu, Steaphan MacRisnidh, Isaac Welsford, Ngalabesi Khokhovula, Dinu Daya, Leybl Botwinik, Yeno Matuka, T. Bluzke, J. Kahn, Sumiyabaatar Enkhbaatar, Daniela Whyte, Mohan Konidela, Nurul Hazarika, Nurzhan Temirkhan, Ludmila Košková Nesbit, Mathew Davis, Michel Bah, Dmitry Volkov, Dina Chandratreya, Johnson Jolicoeur, Talitha Wolmarans, Hamza Faiziyev, Chanida Rungrueang, Rajamanickam Ramu, Sallehuddin Hadi, Tanya Dolly, Ieva Sidaravičiūtė, Mindaugas Gudaitis, Porsteinn Frimann, Nirmal Kumar Bohra, Niniko Georgia, Agris Kostabi, Bethelhem Kuku, Lusine Vartanian, Enrique Muñoz Mantas, Rehana Sardar, Eva Fischer, Petr Hrabec, Lamiya Mammadova, Iliriana Bisha Tagani, Vesna Miletic, Danijel Marković, Sanja

Knezevic, Marija Jovanović, Jahan Kos, Pola Taisali, Arrah Brown, Lyubomir Tomov, Voara Ralaiarijaona, Mialy Razanajatovo, Elspeth Grace Hall, Tshering Tashi, Firuz Jumaev, Bouakeo Sivily, Piseth Kheng, Katharina Martl, Heidi Helgemo, Jingyi Chen, Myat Phyo, Edmund Fairfax, Hroviland Bairhteins, Henry Kow Nyadiah, Rudolf-Josef Fischer, Alejandro Escobedo, Meliha Fazlic, Sanja Knezevic, Francis Holyoak, Kristel Aquino-Estanislao, Eleni Torossi, Christa Blattmann, Sanja Bulatović, Sabina Hona, Liliana Ioan, Carla Moxam, Heidi Alatalo, Marisa Pereira Paço Pragier, Renate Glas, Tania Hoffmann-Fettes, Keung Nguyen, Hanh Vu, Víctor Suárez Piñero, Chi Le, Lobsang Tsering, An Wielockx, Florian Schroiff, Eva Lindeman, Daryna V. Temerbek, Judith Manns, Aminath Mohamed Didi, Galina Konstantinovna Zakharova, Catrine Lindgren, Mai-Le Timonen Wahlström, Dorota Beuker-Herud, Alina Omhandoro, Rizky Ranny Andayani, Oluwatosin Balarabe, Alessandra Sorbello Staub, Francesca Parenti, Andrés Rodas Vélez, Kristina Mørch Hendriksen, Şebnem Karakaş, Varga Tünde, Juga Réka ...



Biografía del autor...



Philipp B. Winterberg M.A., estudió Ciencias de la Comunicación, Psicología y Derecho en Münster y vive en Berlín. Le apasiona llevar una vida polifacética: ha saltado en paracaídas en Namibia, ha meditado en Tailandia y ha buceado con tiburones y rayas en Polinesia.

Sus publicaciones abren nuevas perspectivas sobre temas vitales como la amistad, la conciencia y la suerte. Traducidos a más de 200 idiomas, sus libros se leen por todo el mundo.



